

1.00mm HORIZONTAL SMT LIF CONNECTOR



1766 SERIES. 1.00mm(0.039"). For PCB Solder

Features

- Available in 4 through to 32 circuits
- Insulator Material : Glass filled Nylon 6T; UL 94V-0
- Contact Material: Tin plated Phosphor Bronze

- Full check by CCD and Hi-Pot test
With fixed metal tabs to secure connector in place
- Available in Tube or Reel packing

Dimensional Information

Ordering and dimensional Information

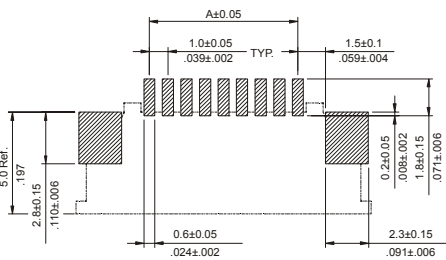
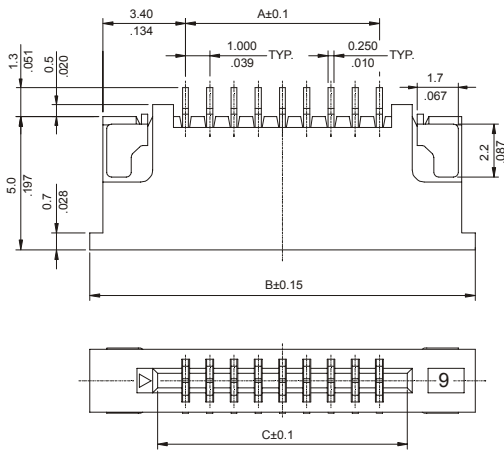

RECOMMENDED PCB LAYOUT

Circuits Size	Part Number	Dimensions		
		A	B	C
04	1766-2041	3,00(0,118)	11,00(0,433)	5,30(0,209)
05	1766-2051	4,00(0,157)	12,00(0,472)	6,30(0,248)
06	1766-2061	5,00(0,197)	13,00(0,512)	7,30(0,287)
07	1766-2071	6,00(0,236)	14,00(0,551)	8,30(0,327)
08	1766-2081	7,00(0,276)	15,00(0,591)	9,30(0,366)
09	1766-2091	8,00(0,315)	16,00(0,630)	10,30(0,406)
10	1766-2101	9,00(0,354)	17,00(0,669)	11,30(0,445)
11	1766-2111	10,00(0,394)	18,00(0,709)	12,30(0,484)
12	1766-2121	11,00(0,433)	19,00(0,748)	13,30(0,524)
13	1766-2131	12,00(0,472)	20,00(0,787)	14,30(0,563)
14	1766-2141	13,00(0,512)	21,00(0,827)	15,30(0,602)
15	1766-2151	14,00(0,551)	22,00(0,866)	16,30(0,642)
16	1766-2161	15,00(0,591)	23,00(0,906)	17,30(0,681)
17	1766-2171	16,00(0,630)	24,00(0,945)	18,30(0,720)
18	1766-2181	17,00(0,669)	25,00(0,984)	19,30(0,760)
19	1766-2191	18,00(0,709)	26,00(1,024)	20,30(0,799)
20	1766-2201	19,00(0,748)	27,00(1,063)	21,30(0,839)
21	1766-2211	20,00(0,787)	28,00(1,102)	22,30(0,878)
22	1766-2221	21,00(0,827)	29,00(1,142)	23,30(0,917)
23	1766-2231	22,00(0,866)	30,00(1,181)	24,30(0,957)
24	1766-2241	23,00(0,906)	31,00(1,220)	25,30(0,996)
25	1766-2251	24,00(0,945)	32,00(1,260)	26,30(1,035)
26	1766-2261	25,00(0,984)	33,00(1,299)	27,30(1,075)
27	1766-2271	26,00(1,024)	34,00(1,339)	28,30(1,114)
28	1766-2281	27,00(1,063)	35,00(1,378)	29,30(1,154)
29	1766-2291	28,00(1,102)	36,00(1,417)	30,30(1,193)
30	1766-2301	29,00(1,142)	37,00(1,457)	31,30(1,232)
32	1766-2321	30,00(1,181)	38,00(1,496)	32,30(1,271)

Notice: In case of connectors in reel (Automatic mounting), add an R at the end of code.

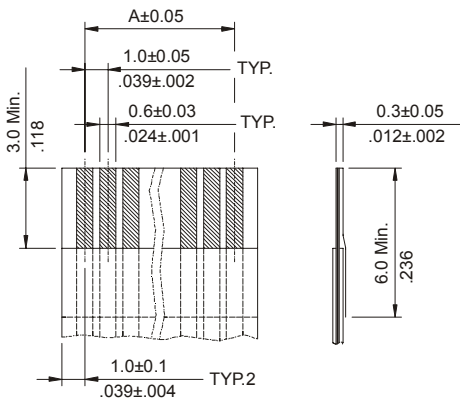
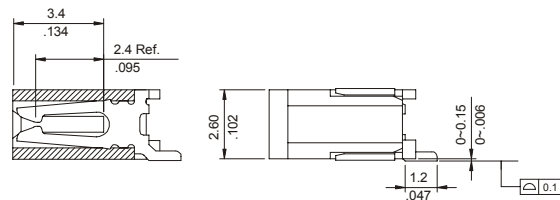

ACCOMMODATED FFC

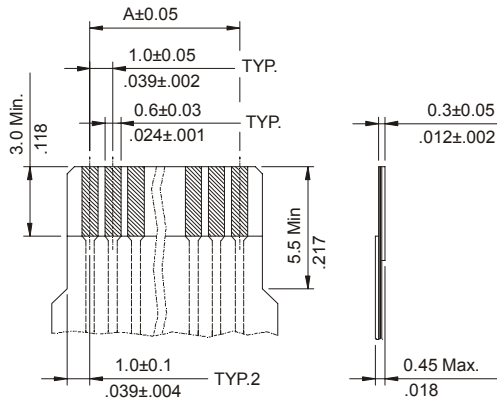

ACCOMMODATED FPC

1,00 mm HORIZONTAL SMT LIF CONNECTOR



SERIE 1766. For Machine Mounting

Features

- Packing in Reel

Circuits	Dimensions			
	E	F	W1	W2
4 - 9	24.0 (0.945)	-	24.40 (0.961)	30.40 (1.197)
10 - 15	32.0 (1.260)	28.40 (1.118)	32.40 (1.276)	38.40 (1.512)
16 - 26	44.0 (1.732)	40.40 (1.596)	44.40 (1.748)	50.40 (1.984)
27 - 32	56.0 (2.205)	52.40 (2.063)	56.40 (2.220)	62.40 (2.457)

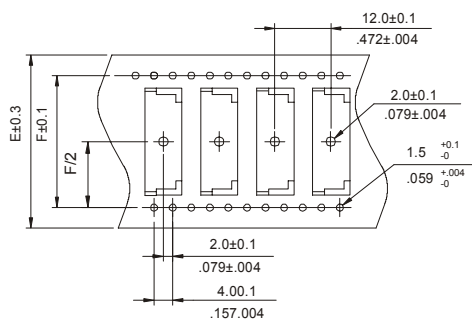
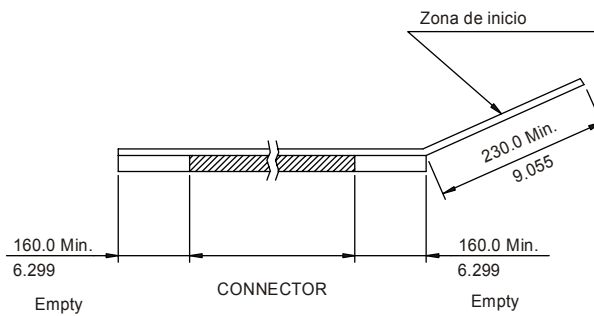
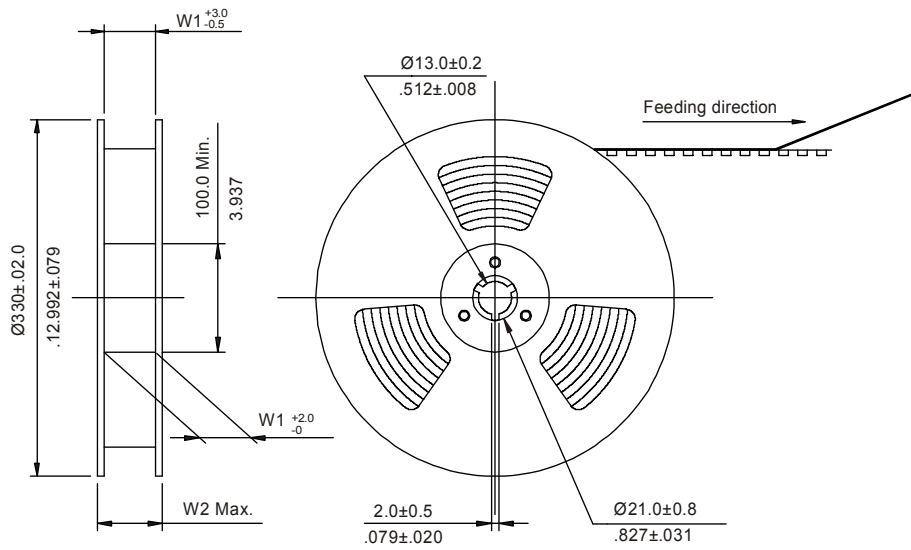

Width: 32 / 44 / 56 mm. Carrier

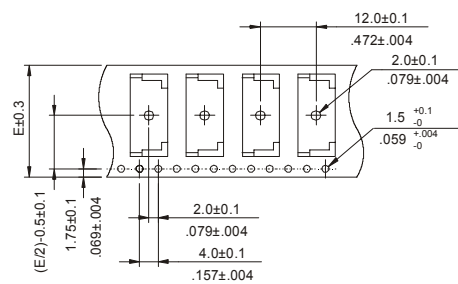

Width: 24 mm Carrier

