

# TYPE A BOARD MOUNT CONNECTOR

## 5600 SERIES Receptacle. For PCB Solder

### Features

- Available in 1 or 2 connectors (4 or 8 Circuits)
- Insulator Material: Glass filled polyester UL 94V-0
- Contact Material: Phosphor Bronze
- Material Shell: Tin Steel
- High durability and long cycle life
- Designed to meet the USB 2.0 Specifications
- With rear shell

### Dimensional Information

### Ordering and Dimensional Information

CONNECTOR TYPE	Part Number
SINGLE	5600 - 3041
DUAL	5600 - 3081

SINGLE VERSION

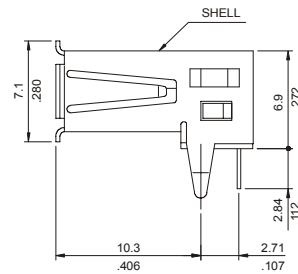
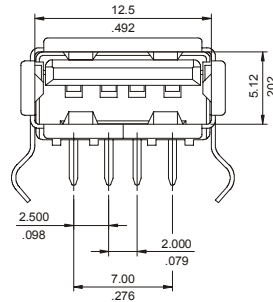
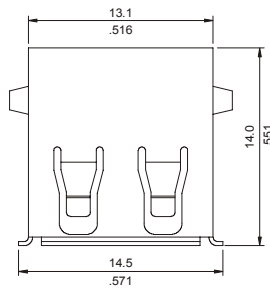

DUAL VERSION

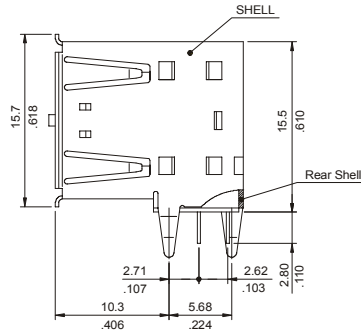
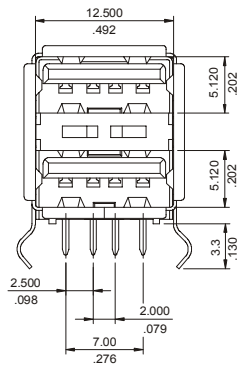
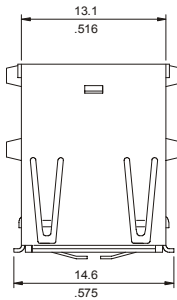

RECOMMENDED HOLE PATTERN

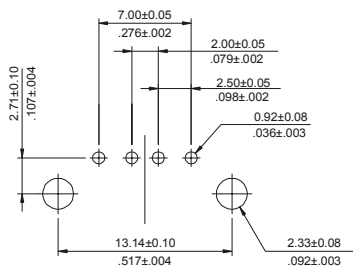

SINGLE VERSION

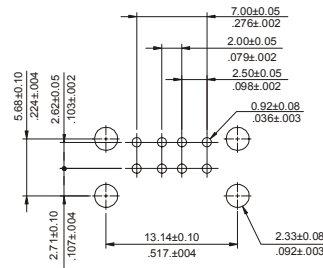

DUAL VERSION