

# 1.00mm HORIZONTAL ZIF CONNECTOR

## 1761 SERIES. 1.00mm(0.039"). For PCB Solder

### Features

- Available in 4 through 32 circuits
- Insulator Material: Nylon 6T UL 94V-0
- Contact Material: Phosphor Bronze
- Zero insertion force and high contact pressure
- Applicable FPC and FFC: Thickness 0.30mm(.012")

### Dimensional Information

### Ordering and Dimensional Information

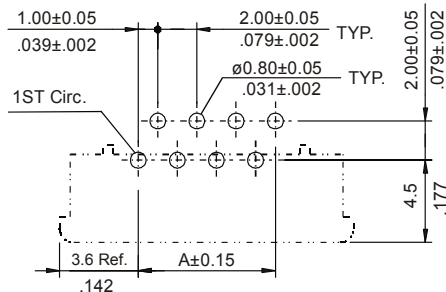
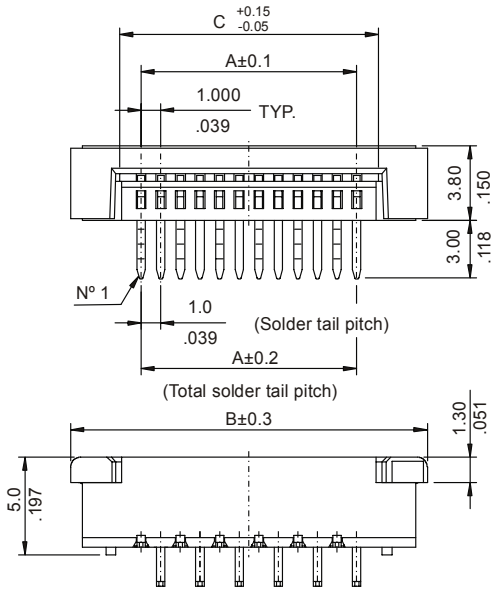

Recommended P.C. Board Layout

Circuit Size	Part Number		Dimension		
	Upsid. Contact	Downside Cont	A	B	C
04	1761-2041	1761-2042	3,00(0,118)	10,20(0,402)	5,20(0,205)
05	1761-2051	1761-2052	4,00(0,157)	11,20(0,441)	6,20(0,244)
06	1761-2061	1761-2062	5,00(0,197)	12,20(0,480)	7,20(0,283)
07	1761-2071	1761-2072	6,00(0,236)	13,20(0,520)	8,20(0,323)
08	1761-2081	1761-2082	7,00(0,276)	14,20(0,559)	9,20(0,362)
09	1761-2091	1761-2092	8,00(0,315)	15,20(0,598)	10,20(0,402)
10	1761-2101	1761-2102	9,00(0,354)	16,20(0,638)	11,20(0,441)
11	1761-2111	1761-2112	10,00(0,394)	17,20(0,677)	12,20(0,480)
12	1761-2121	1761-2122	11,00(0,433)	18,20(0,717)	13,20(0,520)
13	1761-2131	1761-2132	12,00(0,472)	19,20(0,756)	14,20(0,559)
14	1761-2141	1761-2142	13,00(0,512)	20,20(0,795)	15,20(0,598)
15	1761-2151	1761-2152	14,00(0,551)	21,20(0,835)	16,20(0,638)
16	1761-2161	1761-2162	15,00(0,591)	22,20(0,874)	17,20(0,677)
17	1761-2171	1761-2172	16,00(0,630)	23,20(0,913)	18,20(0,717)
18	1761-2181	1761-2182	17,00(0,669)	24,20(0,953)	19,20(0,756)
19	1761-2191	1761-2192	18,00(0,709)	25,20(0,992)	20,20(0,795)
20	1761-2201	1761-2202	19,00(0,748)	26,20(1,031)	21,20(0,835)
21	1761-2211	1761-2212	20,00(0,787)	27,20(1,071)	22,20(0,874)
22	1761-2221	1761-2222	21,00(0,827)	28,20(1,110)	23,20(0,913)
23	1761-2231	1761-2232	22,00(0,866)	29,20(1,150)	24,20(0,953)
24	1761-2241	1761-2242	23,00(0,906)	30,20(1,189)	25,20(0,992)
25	1761-2251	1761-2252	24,00(0,945)	31,20(1,228)	26,20(1,031)
26	1761-2261	1761-2262	25,00(0,984)	32,20(1,268)	27,20(1,071)
27	1761-2271	1761-2272	26,00(1,024)	33,20(1,307)	28,20(1,110)
28	1761-2281	1761-2282	27,00(1,063)	34,20(1,346)	29,20(1,150)
29	1761-2291	1761-2292	28,00(1,102)	35,20(1,386)	30,20(1,189)
30	1761-2301	1761-2302	29,00(1,142)	36,20(1,425)	31,20(1,228)
31	1761-2311	1761-2312	30,00(1,181)	37,20(1,465)	32,20(1,268)
32	1761-2321	1761-2322	31,00(1,220)	38,20(1,504)	33,20(1,307)

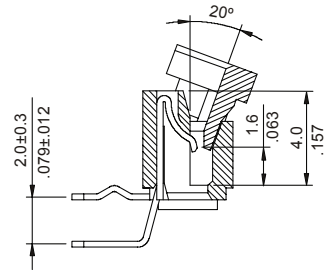

Downside contact

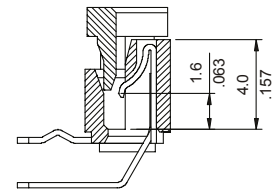

Upside contact

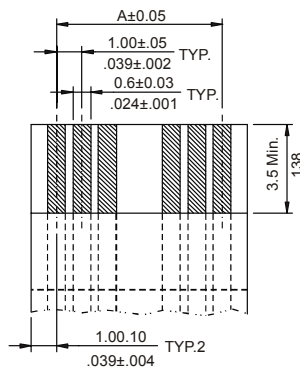

\* ACCOMMODATED FFC

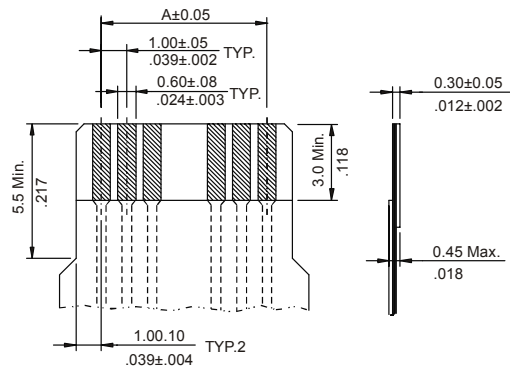
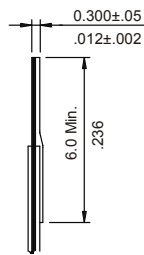

\* ACCOMMODATED FPC