

0.50mm HORIZONTAL SMT ZIF CONNECTOR

0512 SERIES. 0.50mm(0.020"). For PCB Solder

Features

- Available in 20 to 50 circuits
- Insulation: High temperature plastic UL 94V-0 col. nature
- Slider: High temperature plastic UL 94V-0 colour Brown
- Actuator designed easy for FFC/FPC installation
- Actuator designed easy for FFC / FPC installation
- Contact Material: Tin plated Phosphor Bronze
- Downside contact
- Fully check by CCD and Hi-pot test
- With fixed metal tabs to secure connector in place
- Available in Tube or Reel packing

Dimensional Information

Ordering and Dimensional Information

0512 - 2- XX- E
 1 2 3 4

1. SERIAL OF CONNECTOR

2. (T) FINISH OF CONTACTS

- Tin Plated available

3. (XX) CIRCUIT SIZE

- Available in 20 through 50 circuits

6. (E) CODE PACKING

- E = 1. PAD + TUBE
- E = 2. PAD + REEL

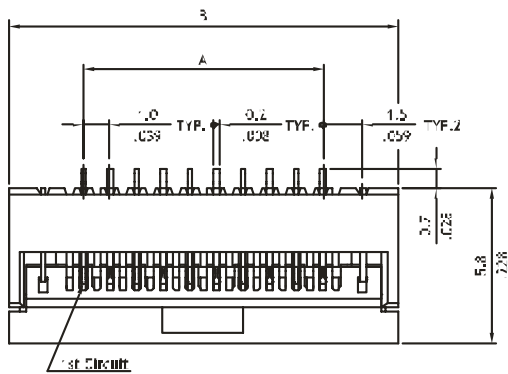

A = 0.50 x No. of Spaces
 B = A + 3.6
 C = A + 2.1

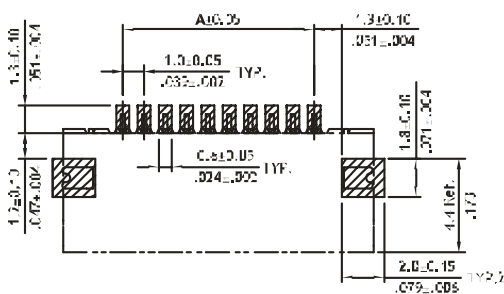
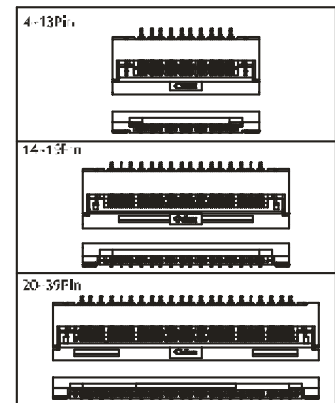
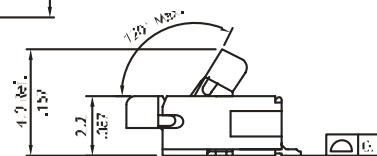
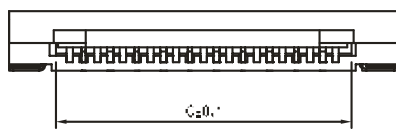

Recommended P.C. Board Layout

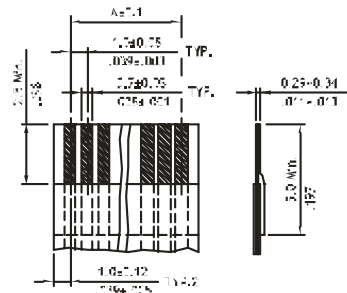
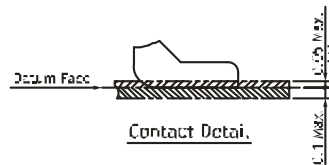

Accommodated FFC/TPC

0.50mm HORIZONTAL SMT ZIF CONNECTOR



0512 SERIES. For Machine Mounting

Features

- Packing in reel

Circuits of connectors	Dimensions				
	E	F	W1	W2	W3
4 - 9	24.0 (0.945)	-	24.40 (0.961)	30.40 (1.197)	24.40 (0.961)
10 - 15	32.0 (1.260)	28.40 (1.118)	32.40 (1.276)	38.40 (1.512)	32.40 (1.276)
16 - 26	44.0 (1.732)	40.40 (1.596)	44.40 (1.748)	50.40 (1.984)	44.40 (1.748)
27 - 32	56.0 (2.205)	52.40 (2.063)	56.40 (2.220)	62.40 (2.457)	56.40 (2.220)

